

IBM

Correcting Selectric® III and
Selectric® III Typewriters
Operating Instructions

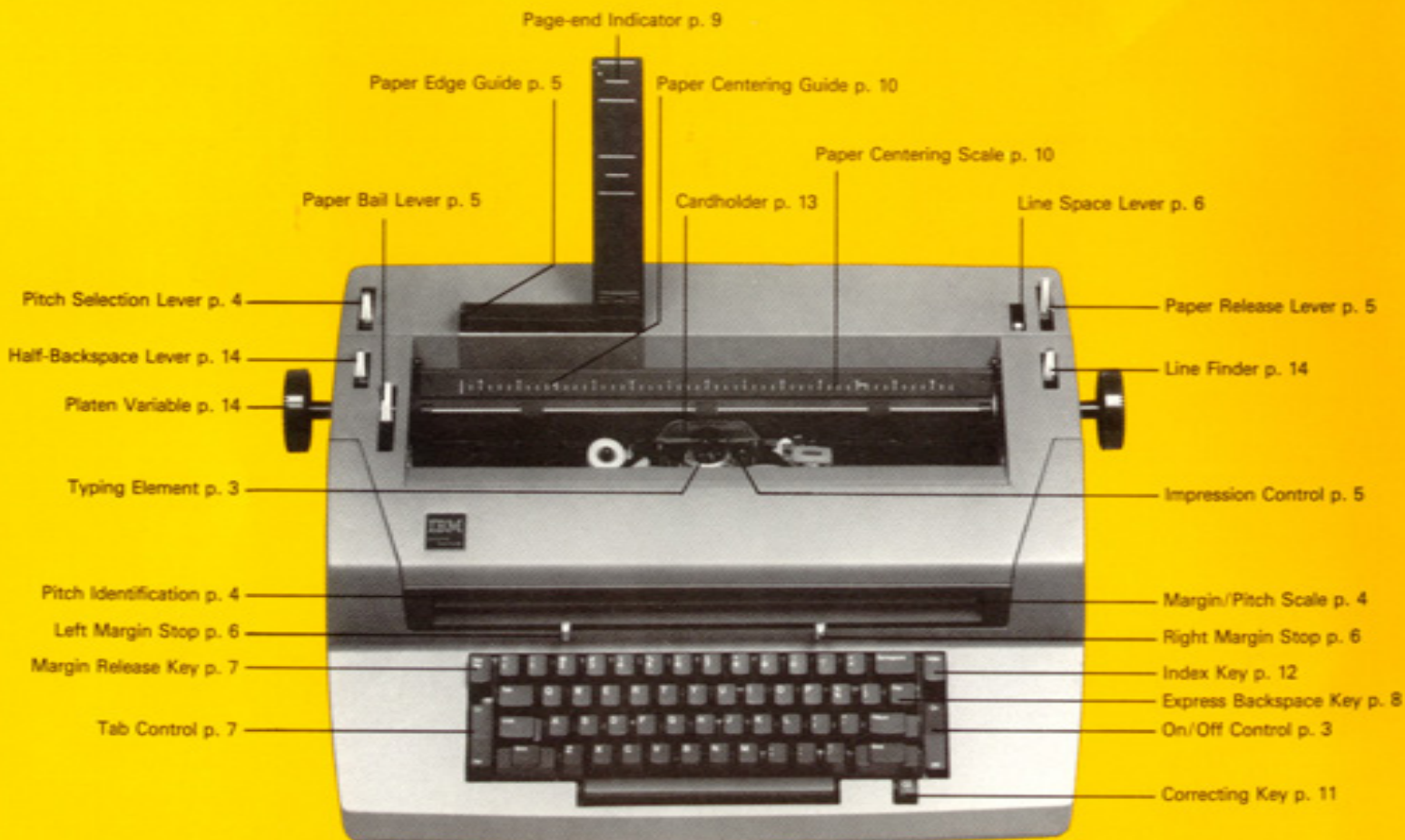

Refer to this photograph to help you locate the individual features of your IBM Correcting "Selectric" III Typewriter and IBM "Selectric" III Typewriter.



Preface	2	As You Type		IBM Supplies	
Preparation		To Make a Correction	11	IBM High Yield Correctable	
On/Off Control	3	To Type Stencils	12	Film Ribbon	19
To Change Element	3	Fabric Ribbon Typewriter	12	IBM Lift-off Tape	19
Margin/Pitch Scale	4	Typamatic Keys	12	IBM Tech III Ribbon	20
Pitch Selection Lever	4	Cardholder	13	IBM Tech III Cover-up Tape	20
Margin/Dual-Pitch Scale	4	To Draw Lines	13	IBM Film Ribbon Cartridge	20
Inserting Paper	5	Line Finder	14	Superior Nylon Ribbon	21
Paper Release	5	Half Backspace Lever	14	Series 7 Carbon Paper	21
Impression Control	5	Platen Variable	14	Typing Elements	22
To Set Margins	6	Care of the Typewriter		Ordering IBM Supplies	22
To Change Pitch Within		Ribbon Systems	15	Element Application Rating	23
a Document	6	Selective Ribbon System	15	Applications Recommendations	
Line Space Lever	6	To Remove a Ribbon	15	for IBM Ribbons	24
Margin Release	7	To Install a Ribbon	15	Optional Features	
To Set and Clear Tabs	7	Fabric Ribbon System	16	Velocity Control Dial	25
Express Backspace Key	8	To Remove a Fabric Ribbon	16	Dead Key	25
Shift Keys and Shift Lock	8	To Install a Fabric Ribbon	16	Dead Key Disconnect	25
Checklist for Proper Typewriter		Ribbon Reverse Lever	16	Acoustical Hood	26
Operations	8	Changing the Correcting Tape	17	Legal Size End-of-Page	
Page-end Indicator	9	To Remove the Tape	17	Indicator	26
To Center Information	10	To Install New Tape	17		
To Center the Paper	10	Serial Number	18		
		Cleaning the Typewriter	18		
		Cleaning the Typing Element	18		
		IBM Service Agreement	18		

Preface

With the IBM Correcting Selectric® III Typewriter, erasures, strikeouts, and messy corrections can be a thing of the past. The IBM High Yield Correctable Film Ribbon and IBM Lift-off Tape system allows you to lift incorrectly typed characters off the page. The IBM Correcting "Selectric" III Typewriter also allows you to use the IBM Tech III Ribbon with the IBM Tech III Cover-up Tape for certain applications.

In addition, both the IBM Correcting "Selectric" III Typewriter and the IBM "Selectric" III Typewriter utilize single-element typing technology.

The following are available on the IBM Correcting "Selectric" III or "Selectric" III Typewriters:

Interchangeable Typing Elements – A choice of over 20 available for every typing need.

Page-end Indicator – As you type down the page, the indicator tells you the amount of space remaining on the paper.

Larger Keybuttons – The keys have been enlarged 25%.

Optional Acoustical Hood – The perfect choice in sound-sensitive working areas.

Express Backspace Key – A major convenience factor when underscoring or rapidly backspacing.

Impression Control – Easy to use and adjust to suit each typing application.

The following are available on the IBM Correcting "Selectric" III Typewriter only:

Dual Pitch – Choose a 10-pitch or 12-pitch type style to suit each application.

Lighted Margin Scale (dual-pitch models only) – The 10- or 12-pitch scale lights according to the pitch selected.

Half Backspace Lever (dual-pitch models only) – Ideal for creating ligatures or correcting already typed copy.

The following instructions and illustrations provide a quick, convenient way to help you realize the full benefits of your new IBM typewriter.

Preparation

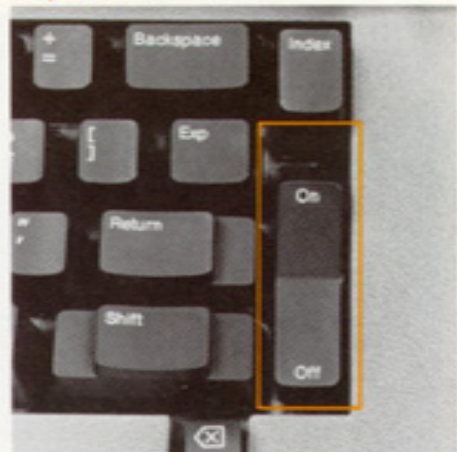

On/Off Control

To turn the typewriter on, depress the top part of the On/Off control.

WARNING: Keep hair, fingers, and personal objects (such as bracelets, necklaces, neckties, etc.) out of the printing and ribbon area when the machine is on.

In order to prevent long hair, fingers, and personal articles from getting caught on the rotating shaft in the machine, you should comply with this warning and ensure that other persons do also.

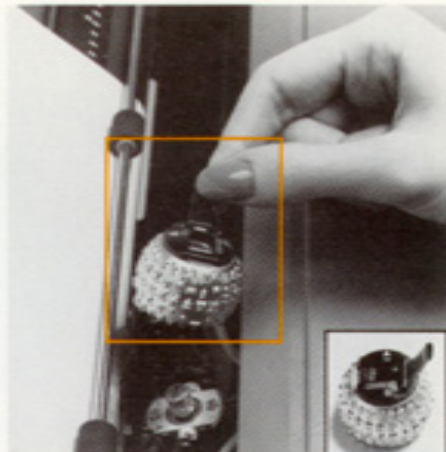

To Change Element

Use an element with a ▲ when typing in 10 pitch and a △ when typing in 12 pitch.

Only elements with *yellow* labeling on the top may be used on this typewriter.

To put on an element

- Tap the shift key to be sure it is not locked.
- Open the lever on top of the element until it is *all the way* open, as shown above.
- Hold the element by the lever and place it on the element post, pointing the yellow triangle toward the platen.
- Close the lever all the way down.

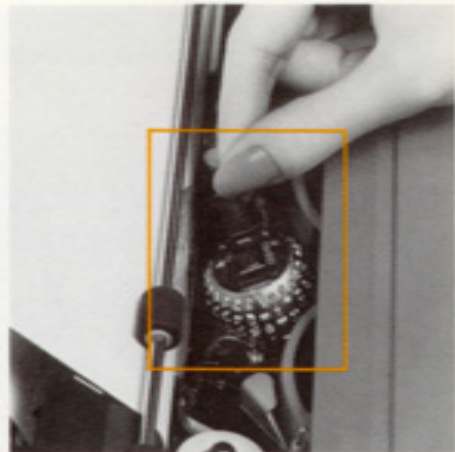

To remove an element

- Tap the shift key to be sure it is not locked.
- Lift the lever on top of the element until it is *all the way* open, as shown above.
- Use the lever to lift the element *straight up* off the element post.

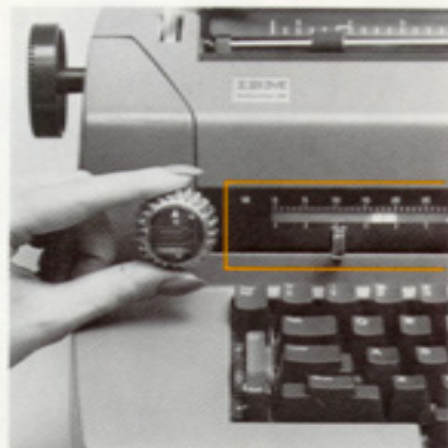

Margin/Pitch Scale

(Single-Pitch Model)

This scale is located directly above the keyboard. The 10 or 12 at the left of the scale indicates the typewriter's pitch.

The scale is numbered every five spaces from left to right.

A white pointer moves along the scale with the carrier, indicating the typing position of the next character to print.

On top of the element is a 10 ▲ or 12 △ indicating the pitch. Use an element with a 10 for a 10-pitch typewriter; use 12 for a 12-pitch typewriter.

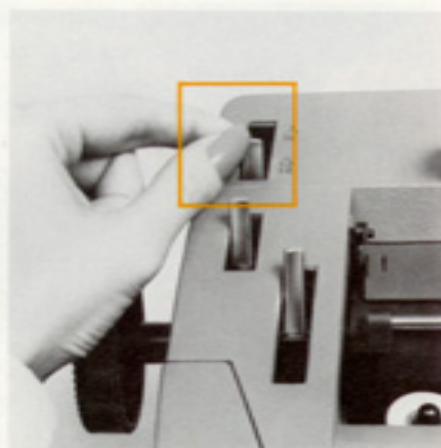

Pitch Selection Lever

(Dual-Pitch Model)

If your typewriter is a dual-pitch model, it is designed to allow typing in either 10 or 12 pitch.

Move the pitch selection lever toward you for 12-pitch typing and away from you to type in 10 pitch.

10 pitch (Pica):

10 characters per inch

12 pitch (Elite):

12 characters per inch



Margin/Dual-Pitch Scale

(Dual-Pitch Model)

The dual-pitch model has a lighted margin scale. For your convenience, only the scale corresponding to the pitch in use will light.

- Moving the pitch selection lever switches the illumination from one scale to the other.

A red pointer moves along the scale with the carrier, indicating the typing position of the next character to print.

Use an element with a 10 ▲ when typing in 10 pitch; use a 12 △ for 12 pitch.

Note: Using a typing element of one pitch when the typewriter is set for the other pitch will alter only the amount of space between characters.

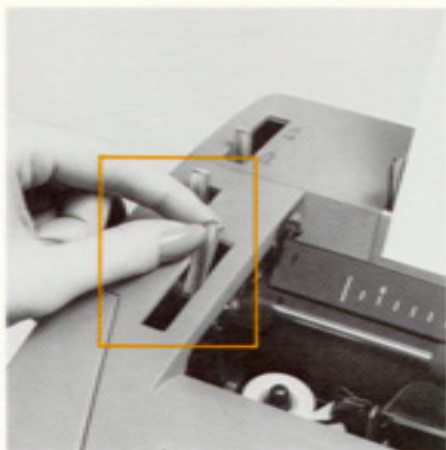

Inserting Paper

Align the paper against the paper edge guide.

Pull the paper bail lever forward.

Depress the index key to roll the paper into the typewriter.



Paper Release

To remove the paper or to reposition the paper after it is inserted in the typewriter, pull the paper release lever forward.

- Use this feature when inserting a thick carbon pack.

Push this lever back after the paper has been removed or is in the desired position.

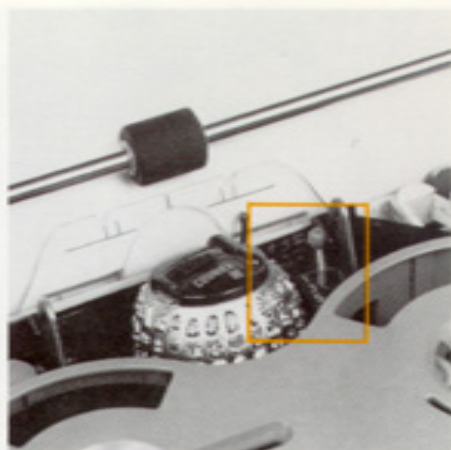

Impression Control

The impression control adjusts the striking force of the element. For most jobs, set the control on three.

- Move the control to the right before changing the position.

For greater striking force, move the control to a higher number (example, multiple carbon packs, stencils.)

For less striking force, move the control to a lower number (example, offset masters).

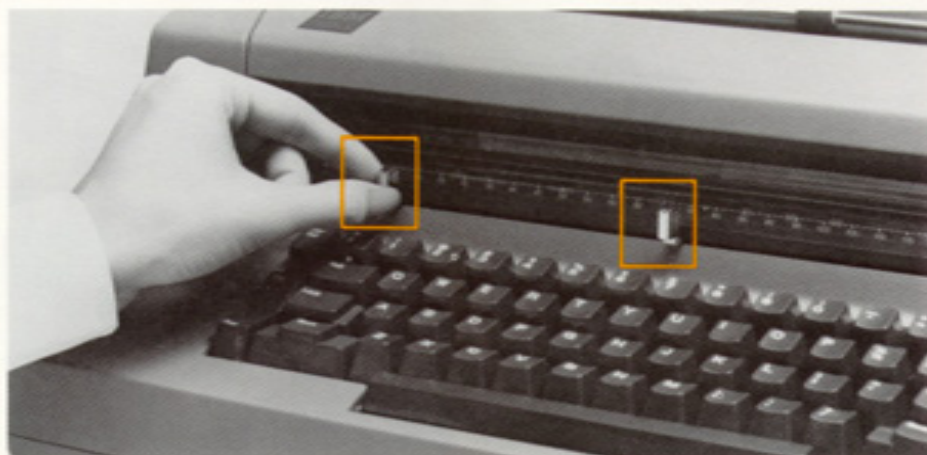

To Set Margins

Push in and slide the margin stops to the new margin setting.

The left margin stop cannot be moved to the right beyond the pointer. Use the spacebar to move the pointer out of the way before moving the margin stop.

- You can also use the margin release key (page 7).

The right margin stop prevents you from typing past the right margin; however, you can space or tab through it. To type past the right margin, depress the margin release key (page 7) and continue typing.

Note: On dual-pitch models, there is a white indicator to show where the left margin stop is.

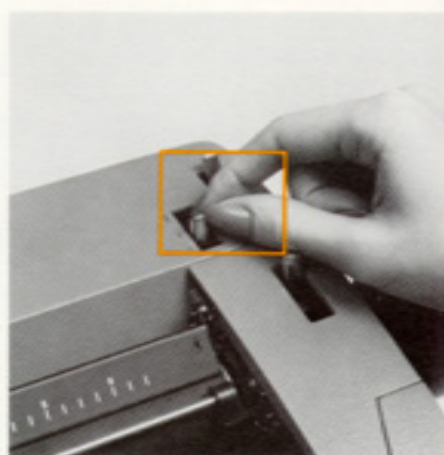

Line Space Lever

Move the line space lever toward you for single spacing, to the middle mark for space-and-a-half spacing, and away from you for double spacing.

- Your typewriter may have single and double spacing. You may want to check the spacing in your typewriter.



Margin Release

To temporarily release the left margin, return the carrier to the left margin, depress the margin release key, and backspace through the margin.

To type through the right margin after the keyboard locks, depress the margin release key and continue typing.

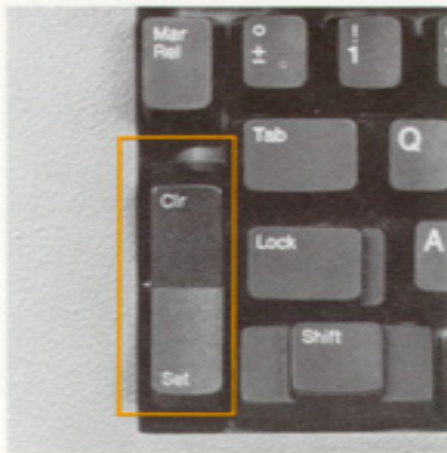

To Set and Clear Tabs

Use the tab control to set and clear tabs. To set a tab, move the carrier to the space where you want to set a tab and depress Set.

To clear a tab, tab to the stop you want to clear and depress Clr.

To clear all tabs at once, tab the carrier all the way to the right; hold down Clr as you depress the carrier return or the express backspace key.

(Dual-Pitch Model) If a document will contain both pica and elite, set your tabs at a numbered marking on the 10-pitch margin scale.

The pointer should be at least two spaces before a tab stop in order to tab to that position.

Hints:

A partial carrier return can be used to type tabulated materials, such as columns of figures or addresses on envelopes.

Set tab stops first. Then tap the carrier return followed by the tab key as soon as the carrier passes the tab stop.

Typing forms is faster when you set tab stops at the points on the form where most of the typing begins. Use the partial carrier return to go directly to a predetermined point on the page; that is, tap the carrier return followed by the tab key as soon as the carrier passes the tab stop.



Express Backspace Key

Use the express backspace key (Exp) to move backward on the same typing line for underscoring or repositioning the carrier. The carrier will continue to move back toward the left margin as long as the key is held down.



Shift Keys and Shift Lock

To type capital and other upper case characters, depress either the left or right Shift key.

To lock the shift key for continuous use, depress Lock.

To unlock the shift key, depress the left or right Shift key.

Checklist for Proper Typewriter Operation

- If typewriter does not turn on, be sure the electric cord is plugged into the outlet.
 - The On portion of the On/Off should be depressed.
- If nothing prints on the paper, make certain the ribbon/stencil control (page 12) is not in the stencil position.
- If the carrier will not move, turn the typewriter *off* for a few seconds, then *on*. Depress the margin release key or tab key to release the carrier.
- If erratic line spacing occurs, check to see that the line finder (page 14) is not forward.
- If the ribbon is not printing properly, make sure that the ribbon (page 15) and the correcting tape (page 17) have been installed correctly.
 - On a fabric ribbon typewriter, reverse the ribbon manually (page 16) and continue typing.
- If characters are crowded or too far apart, check to see if the pitch selection lever matches the element.
- If an element has been dropped or if erratic character spacing occurs, check the bottom of the element for a broken tooth. If a tooth is broken, the element will have to be replaced.



Page-end Indicator

The page-end indicator will:

- Show you approximately how far you are from the bottom of a page.
- Support the paper for easy viewing.

For paper inserted vertically

Use the top three lines on the indicator for paper inserted vertically.

For paper inserted horizontally

Use the lower three lines on the indicator for paper inserted horizontally.

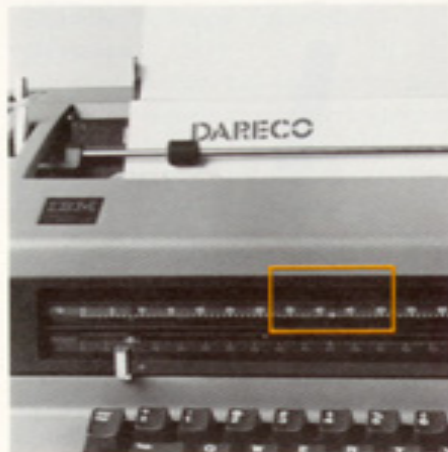
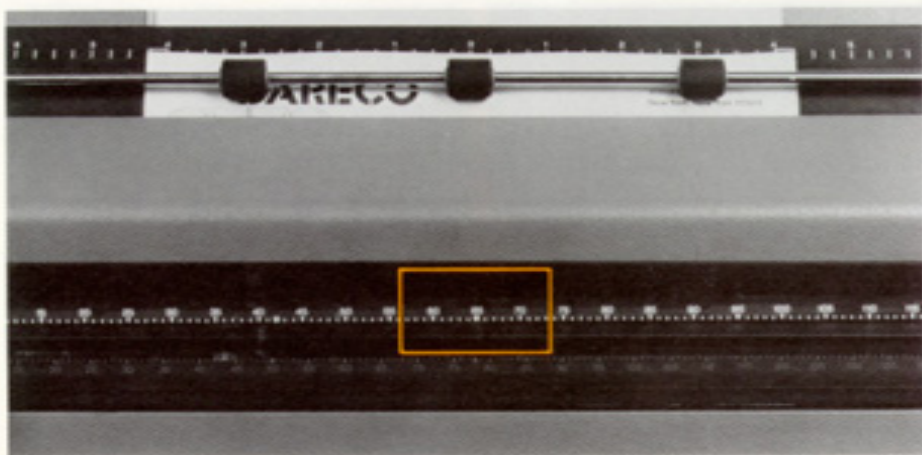

To Center Information

Horizontally

- Move the carrier to the center of the paper.
- Backspace once for every two characters to be centered.
- Type the information.

Vertically

Normal typewriter spacing provides six vertical lines per inch or 66 lines per standard page, 11 inches (279.40 mm) long.

- Use the page-end indicator (page 9) to gauge the bottom margin.

To Center the Paper

To center any width paper, insert the paper so that its left and right edges touch the same number on the paper centering scale. For example, for paper 8½ inches (215.90 mm) wide, both edges touch 4.

- When paper is centered in the typewriter, the dot in the center of the margin scale is the center of the page. See illustration above.

When paper is inserted so that the left edge is aligned with zero on the margin scale, use the first dot for the center of paper 8½ inches (215.90 mm) wide.

As You Type

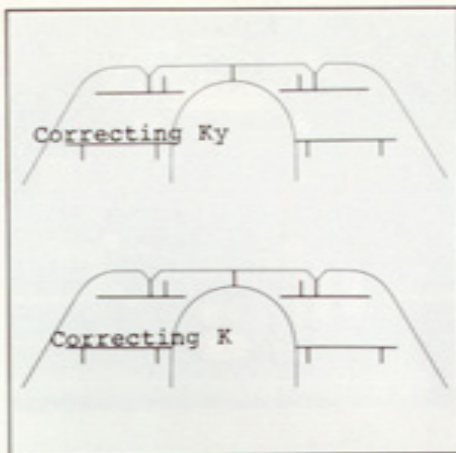
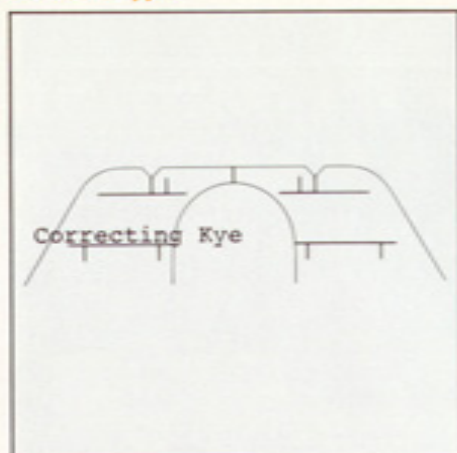

To Make a Correction

1. Depress the correcting key  to backspace to the last incorrectly typed character.
 - The correcting key is typamatic (repeat action), so you can quickly backspace to correct any character toward the beginning of the line.
2. Restrike the last incorrectly typed character to delete it from the paper.
3. Backspace with the correcting key to the next incorrect character and restrike it to delete it from the paper. Repeat until all incorrect characters are deleted.
4. Type the correct character(s).

If you are typing carbon copies, correct them in the usual way after deleting the character(s) from the original.

If you space after backspacing with the correcting key, the correcting process is released.

Use either IBM High Yield Correctable Film Ribbon with IBM Lift-off Tape or IBM Tech III Ribbon with IBM Cover-up Tape.* It is necessary to match the appropriate tape and ribbon. For your convenience, they are color coded.

*When typing offset masters do not use:

- The IBM High Yield Correctable Film Ribbon, or
- The correcting key when using the IBM Tech III Ribbon.

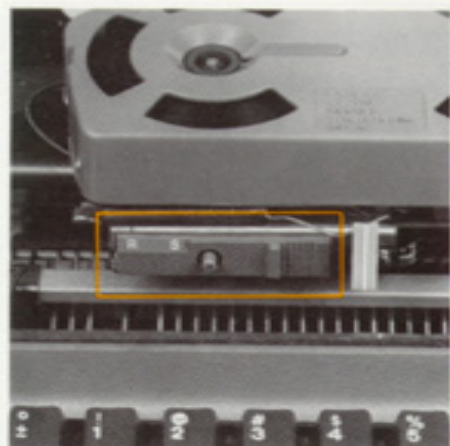

To Type Stencils

Selective Ribbon System

To type stencils, push the ribbon/stencil control in and to the left so the "S" lines up under the mark. Release to lock into place.

To return to regular typing, push the button on the control. This automatically moves the control to printing position.

Fabric Ribbon System

To type stencils, move the ribbon/stencil control to position "0."

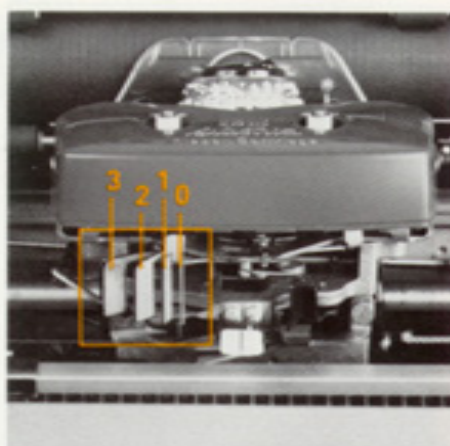

Fabric Ribbon Typewriter

For regular typing, set the control on "1," "2," or "3" to type on the top, middle, or bottom portion of the ribbon. Change the position frequently to allow the ribbon to re-ink itself for longer life.

For red/black ribbons, set the control at position "1" to type in black and at position "3" to type in red.



Typamatic Keys

Typamatic keys have both a single and repeat action. Any of the typamatic keys can be touched lightly for single action or depressed and held all the way down for repeat action.

- Backspace
- Spacebar
- Hyphen/Underscore
- Index*
- Correcting key (available on the IBM Correcting "Selectric" III Typewriter only)
- Carrier Return

*Index key is used to space down the page without the carrier returning to the left margin.



Cardholder

The cardholder holds paper, cards, and envelopes close to the platen.

- The red vertical line at the top center of the cardholder indicates the position of the next character to be typed.

To realign characters for a correction, use the markings on the cardholder as a guide. First, position the characters in the small vertical lines at the top of the cardholder. Then, roll the paper down to the horizontal line at the bottom of the cardholder. This line indicates the base of the typing line. Position your paper so the bottom of each character rests just above the line, as illustrated above.



The red vertical line on the cardholder can also be used to realign characters.

Position an "i" or an "l" directly under the vertical line at the top of the cardholder. Then, roll the paper down to the horizontal line at the bottom of the cardholder. This line indicates the base of the typing line. Position your paper so the bottom of each character rests just above the line.

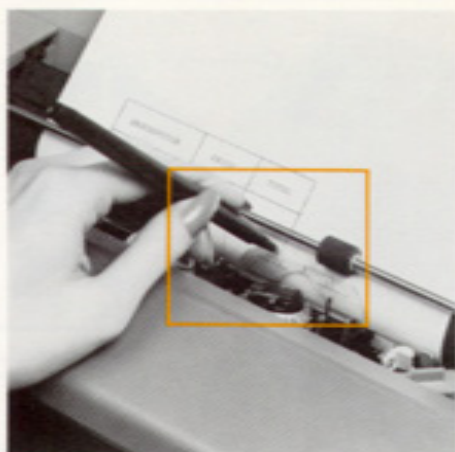

To Draw Lines

You may use the notches on the cardholder to draw vertical lines.

Pull the line finder lever (page 14) forward so you can roll the platen freely.

Remember to return the lever to its original position for normal line spacing.

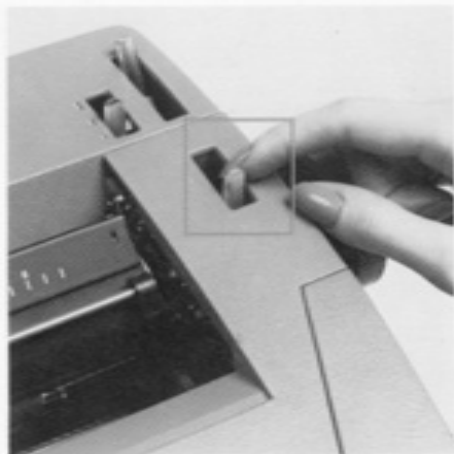

Line Finder

The line finder allows you to temporarily leave the original typing line to type a superscript, subscript, double underscore, a form with irregular spacing, or to draw lines.

- Pull the line finder lever toward you.
- Turn the platen knob to move to the temporary typing line and type.
- To return to the original typing line, push the lever away from you. Then roll the platen to the original typing line.

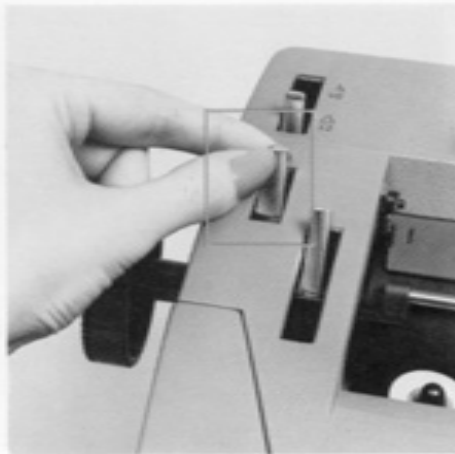

Half Backspace Lever (Dual-Pitch Model Only)

Use this lever to spread or squeeze characters or create a ligature (example, \mathfrak{aem}).

- Pull the half backspace lever forward and hold.
 - Carrier moves back one-half space.
- Type the character(s).
- Release the half backspace lever.
 - Carrier moves forward to its normal typing position.

Note: Typing with the lever forward allows regular character spacing, but one-half space out of the normal typing position.

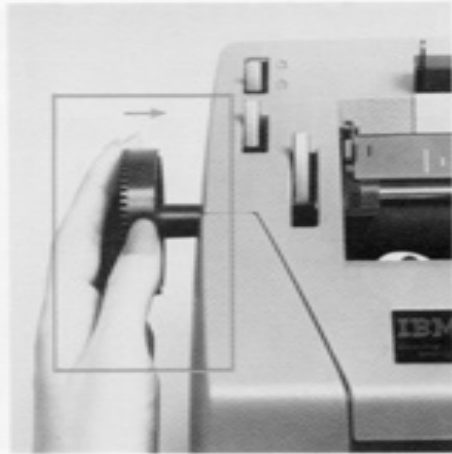

Platen Variable

Press in the left platen knob to permanently change the position of the writing line or to realign a page for corrections or additions.

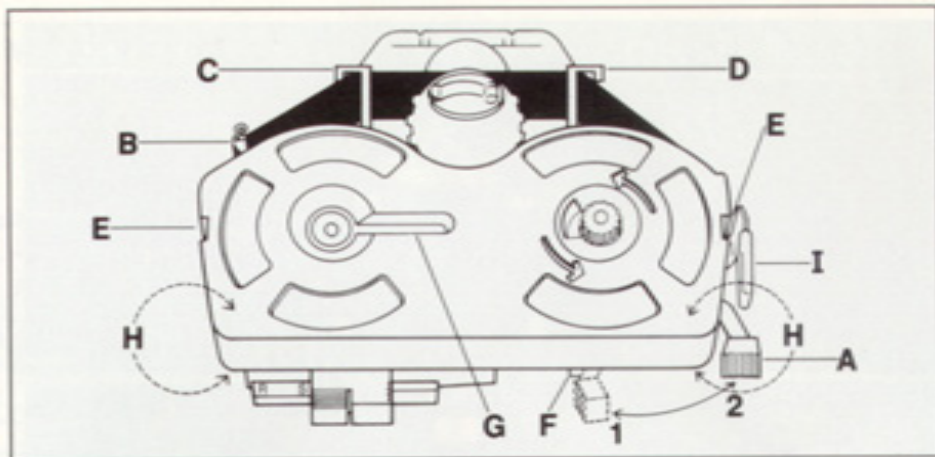

Ribbon Systems

The IBM Correcting "Selectric" III Typewriter offers a selective ribbon system: IBM High Yield Correctable Film Ribbon with IBM Lift-off Tape, or the IBM Tech III Ribbon with IBM Tech III Cover-up Tape. Both are quickly and easily installed. And, to avoid any confusion, both types are color coded — ribbon cartridge with corresponding correcting tape.

The IBM "Selectric" III Typewriter is equipped with a selective ribbon system which accepts either an IBM Tech III Ribbon or a film ribbon. A fabric ribbon system is also available.

Choose the ribbon system instructions that correspond to the ribbon system on your typewriter.

Selective Ribbon System

To see how much ribbon remains in the cartridge, look at the ribbon end indicator (G).

To remove a ribbon

- Center the carrier and turn the motor off.
- Lift the cover.
 - If your typewriter has an acoustical hood, pull it toward you before lifting the cover.
- Keep the paper bail against the platen.
- Move the ribbon load lever (A*) to load position (1) until it snaps against the stop (F).
- Using both hands, hold the ribbon cartridge at the front corners (H) and lift straight up.

*The ribbon load lever on the IBM Correcting "Selectric" III Typewriter cannot be moved if the tape load lever (I) is in the load position.

To install a ribbon

- Be sure the ribbon load lever (A) is in the load position (1).
- Put the ribbon leader (uninked portion) on the *outside* of the guidepost (B) and ribbon guides (C) and (D). *Failure to do so will cause ribbon breakage.*
- Position the ribbon cartridge so that it fits between the spring clips (E). *Firmly push down* both ends of the cartridge.
- Thread the leader through ribbon guides (C) and (D).
- Turn the knob on the cartridge in the direction of the arrow until the leader disappears inside the cartridge.
- Move the ribbon load lever (A) to the type position (2).
- Close the cover.

Note: The name and reorder number of each ribbon appear on the underside of the ribbon cartridge.

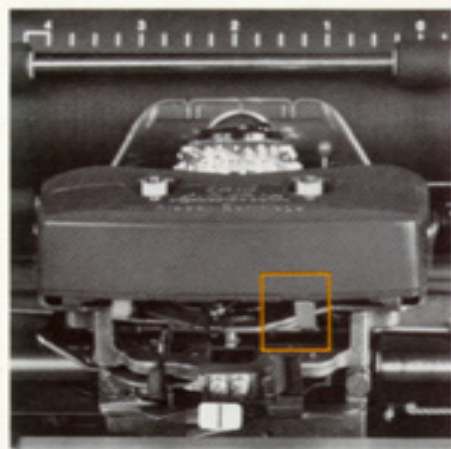
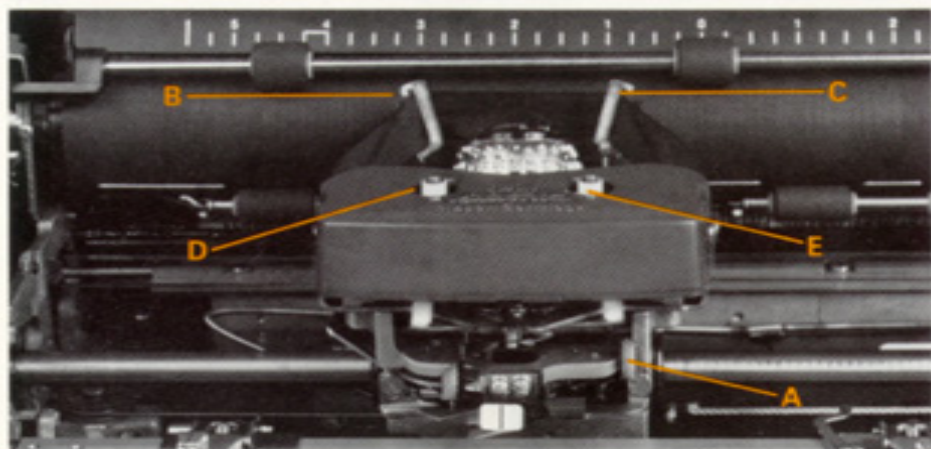

Fabric Ribbon System

To remove a fabric ribbon

- Center the carrier; then, turn the motor off.
- Lift the cover.
 - If your typewriter has an acoustical hood, pull it toward you before lifting the cover.
- Keep the paper bail against the platen.
- Move the ribbon change lever (A) to the far right to raise ribbon guides (B) and (C).
- Lift the cartridge upward and off the spindles (D) and (E).
- Ease the ribbon out of the ribbon guides (B) and (C).

To install a fabric ribbon

- The carrier should remain centered and the motor off.
- Keep the paper bail against the platen.
- Be sure that the ribbon change lever (A) is at the far right.
- Position the cartridge in front of ribbon guides (B) and (C) and thread the ribbon through these guides.
- Place the cartridge on the spindles (D) and (E) and press down.
- Move the ribbon change lever (A) into the typing position.
- To take up the slack in the ribbon, turn either spindle (D) or (E) in the direction of the arrows.

Note: The name and reorder number of each ribbon appear on the underside of the ribbon cartridge.

Ribbon Reverse Lever

(Fabric Ribbon Model Only)

Fabric ribbons reverse automatically when either side of the carriage becomes empty. However, to manually reverse the ribbon, press the ribbon reverse lever nearest you to the rear.

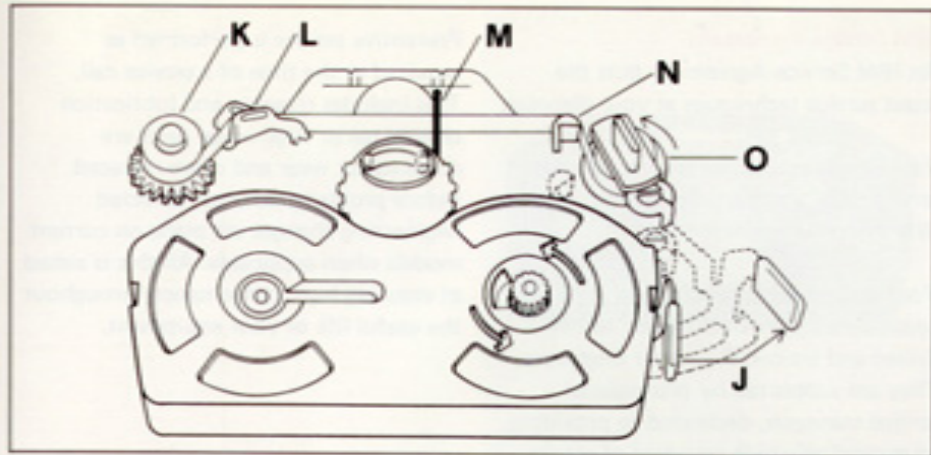

Changing the Correcting Tape

To remove the tape

- Move the tape load lever (J) to the right.*
- To lift off the empty tape spool (K), twist slightly clockwise; remove take-up spool.

*The tape load lever cannot be moved if the ribbon load lever is in the load position.

To install new tape

Remember: Use an orange spool with a ribbon which has an orange knob; use a blue spool with a ribbon which has a blue knob.

- Gently separate the two spools, but keep them connected by the orange or blue tape (leader).
- Place new tape spool (K) on the left spindle.
- Thread the leader through the guide (L), behind the separator wire (M), and behind the guide (N).
- Place the take-up spool (O) on the right spindle. Turn the take-up spool in the direction of the arrow until the leader is past the guide.
- Move the tape load lever (J) to the left. (The lever must be closed before you begin to type.)

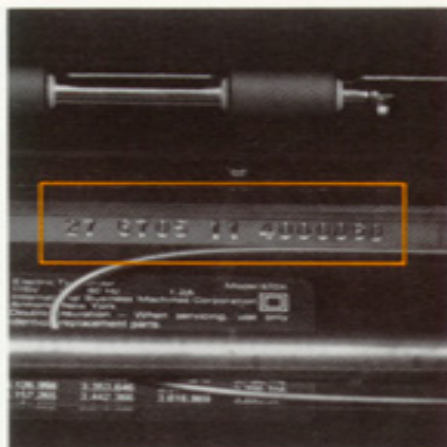

Serial Number

To locate the serial number:

- Tab the carrier all the way to the right.
- Raise the typewriter cover.
- Locate the number directly below the platen toward the left on the metal bar as shown in the illustration.

Cleaning the Typewriter

Use only a mild detergent to clean the plastic parts and painted portions of the typewriter since certain cleaning fluids may be harmful. Where stubborn stains persist, consult your local IBM Service Department.

Cleaning the Typing Element

Remove the element from the typewriter and use a dry brush and cloth to clean the typing element.

IBM Service Agreement

An IBM Service Agreement puts the latest service techniques at your disposal.

You receive corrective service, unlimited service calls, and parts replacement during IBM's normal business hours.

Your equipment is serviced by a coordinated team of efficient, highly skilled and trained Customer Engineers. They are supported by professional service managers, dedicated to providing an exceedingly high standard of service.

Parts replacement is made at no additional charge. Parts availability is maintained by a computerized distribution network.

Customer Engineers respond to your calls by radio dispatch in most locations. Charge for travel time and mileage is included in the basic Service Agreement. Basic Service Agreement includes travel up to 16 miles from the nearest point of service.

Preventive service is performed as required at the time of a service call. This includes cleaning and lubrication of vital parts. High usage parts are checked for wear and often replaced before problems develop. Selected engineering changes are made on current models when applicable. All this is aimed at ensuring high performance throughout the useful life of your equipment.



IBM High Yield Correctable Film Ribbon

Ideal for typing original documents. Designed specifically for correspondence typing. Best results are obtained with less than three carbon copies. Carbon copy sheets should be lightweight, smooth surfaced paper. Carbon paper weight should not exceed 6 lbs. (22.5 grams) in weight. The first or original sheet should be a good 16-20 lb. (60-75 grams) bond paper.

Since the receptivity of the surface of these papers varies, it is best to first try the ribbon on the paper to be used. It is *not* recommended for OCR, Direct Image Offset Masters, Photo-Master Paper or Negotiable Instruments. Type styles larger than Courier *will not* achieve maximum results. This ribbon is *not* recommended for use with Orator type style. For these applications the IBM Tech III ribbon should be used.

Equipment: IBM Correcting "Selectric" III Typewriter with the selective ribbon system

Average Annual Usage: 12-16 ribbons

Shelf Life: Three years

Colors: Black, Medium Blue, Medium Green, Dark Brown

Average Character Yield: 150,000

Packaging: 6 ribbons per box
(Minimum order - 2 boxes)

Reorder Numbers:

Black: 1299095

Medium Blue: 1299361

Medium Green: 1299362

Dark Brown: 1299363

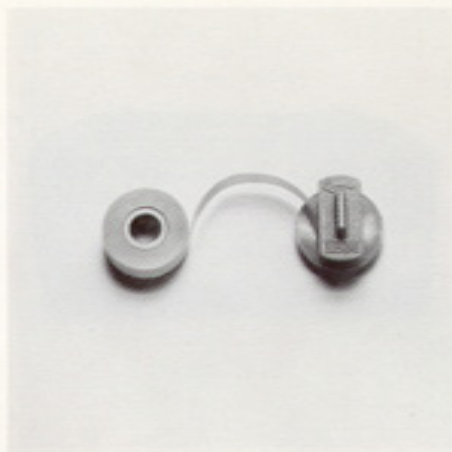

IBM Lift-off Tape

Works in tandem with IBM High Yield Correctable Film Ribbon to lift incorrectly typed characters off the page. Some thin papers such as air mail papers are not recommended. Try the tape on the paper first.

Equipment: IBM Correcting "Selectric" III Typewriter

Average Annual Usage: 12-16 ribbons

Shelf Life: Two years

Color: White

Average Character Yield:

Approximately 2,000 corrections

Packaging: 6 tapes per box
(Minimum order - 1 box)

Reorder Number: 1136433



IBM Tech III Ribbon

Ideal for all general-purpose typing, offset masters, hard-to-image surfaces, and some OCR applications.

Equipment: IBM "Selectric" III Typewriter (with or without correction capability) equipped with the selective ribbon system.

Average Annual Usage: 3-6 ribbons

Shelf Life: Two years

Average Character Yield: 580,000

Color: Black

Packaging: 2 ribbons per box
(Minimum order - 1 box)

Reorder Number: 1136391



IBM Tech III Cover-up Tape

Developed to work in combination with IBM Tech III Ribbon to cover up incorrectly typed characters. Not recommended for Direct Image Offset Masters.

Equipment: IBM Correcting "Selectric" III Typewriter

Average Annual Usage: 12-16 ribbons

Shelf Life: Three years

Color: White

Average Character Yield:

Approximately 2,000 corrections

Packaging: 6 tapes per box
(Minimum order - 1 box)

Reorder Number: 1136435



IBM Film Ribbon Cartridge

Suited for general-purpose typing, offset masters, OCR applications.

Equipment: IBM "Selectric" III and Correcting "Selectric" III Typewriter* equipped with the selective ribbon system.

Average Annual Usage: 16-20 ribbons

Shelf Life: Three years

Colors: Black, Medium Blue, Medium Green, Dark Brown

Average Character Yield: 120,000

Packaging: 6 ribbons per box
(Minimum order - 2 boxes)

Reorder Numbers:

Black: 1136390

Medium Blue: 1136388

Medium Green: 1136386

Dark Brown: 1136383

*You cannot correct with the correcting key.



Superior Nylon Ribbon

For general correspondence typing. The red ink in bi-color ribbons does not reproduce on Thermofax¹ equipment.

Equipment: IBM "Selectric" III Typewriter with the fabric ribbon system.

Average Annual Usage: 6 ribbons

Shelf Life: Three years

Colors: Black, Black/Red, Medium Blue, Medium Green, Medium Brown

Packaging: 3 per box (Minimum order — 1 box)

Reorder Numbers:

Black: 1136138

Black: 1136077 (60 inking)

Black/Red: 1136110

Medium Blue: 1136026

Medium Green: 1136028

Medium Brown: 1136030

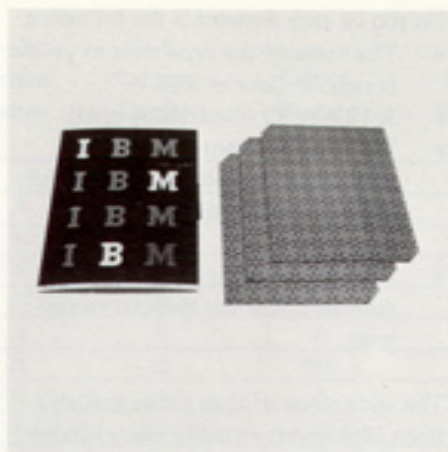

Series 7 Carbon Paper (752)

Long-wearing, dry writing, smudge-proof copy. Paper re-inks itself.

Average Annual Usage: 200 to 300 sheets

Sizes: 8 $\frac{1}{2}$ " x 11 $\frac{1}{2}$ " (215.90 x 292.10 mm) or 8 $\frac{1}{2}$ " x 14 $\frac{1}{2}$ " (215.90 x 368.30 mm).

- For special sizes consult your IBM Representative.

Shelf Life: 18 months

Color: Black

Packaging: 50 sheets per folder. Two folders per box. (Minimum order — 2 boxes).

Reorder Numbers:

8 $\frac{1}{2}$ " x 11 $\frac{1}{2}$ ": 1023763

8 $\frac{1}{2}$ " x 14 $\frac{1}{2}$ ": 1023764

¹Trademark of the 3M Company.



Typing Elements

The IBM Correcting "Selectric" III and the IBM "Selectric" III Typewriters incorporate interchangeable element technology for the greatest versatility and flexibility in typing. When changing typing applications, simply change the typing element.

Note: Only elements with yellow labeling may be used on this typewriter.

On top of each element is the following:

- The name of the type style in yellow (example, Courier 96).
- A 10 ▲ or 12 △ indicating pitch.
- The black element release lever (except on elements with a specially requested character which have a white lever).
- A four- or five-digit identification number under the element release lever.

The wide range of type styles available from IBM covers virtually every typing application, from general correspondence to specialized formats. You'll find one right for every typing job. You can even order type elements applicable to specific industries and foreign languages — with special characters, punctuation marks, and symbols. If you don't find the typing elements just right for you among the standard keyboard arrangements, ask your IBM Representative about additional elements.

Note: Using a typing element of one pitch when the typewriter is set for the other pitch will alter only the amount of space between each character.

Ordering IBM Supplies (U.S.A. Only)

Any IBM Office Products Division supply item can be ordered in the continental United States by contacting your local IBM Office Products Division Branch Office or by calling IBM DIRECT at the following toll-free numbers (Alaska, Hawaii, and Puerto Rico are excluded):
800-631-5582
800-352-4960 (New Jersey)

Element Application Rating*

Type Style	Original	1-3 Carbon Copies	3-5 Carbon Copies	Offset Masters	Spirit Masters	Stencils
12 pitch						
Adjutant	A	A	B	A	B	B
Artisan	A	A	B	A	B	B
Auto Elite	A	A	B	A	A	A
Courier 12	A	A	B	A	B	B
Courier 12 Italic	A	A	B	A	B	B
Dual Gothic	A	B	C	NR	NR	B
Elite	A	A	A	A	A	A
Large Elite	A	A	B	A	A	B
Letter Gothic	A	A	A	A	B	B
Light Italic	A	A	A	A	A	A
Prestige Elite	A	A	B	A	A	A
Scribe	A	A	A	A	A	A
Script	A	B	C	A	C	C
Symbol	A	C	C	B	C	C
10 pitch						
Advocate	A	A	A	A	A	A
Bookface Academic	A	B	C	A	B	B
Courier 10	A	A	B	A	B	B
Delegate	A	A	B	A	B	C
Manifold	A	A	A	A	B	B
Orator	B	C	NR	C	C	NR
Pica	A	A	A	A	A	A
Prestige Pica	A	B	C	A	B	B
Symbol	A	C	C	B	C	C

*Ratings:

A – Good; B – Fair; C – Marginal; NR – Not Recommended
 (Based on proper selection of ribbon, carbon paper, stencils, etc.)

Applications Recommendations for IBM Ribbons

	Tech III	High Yield Correctable Film	Film Ribbon Cartridge	Fabric
Typing Applications				
Legal Correspondence	•	•	•	
Statistical Correspondence	•	•	•	•
Specification Writing	•	•	•	•
Medical Reports	•	•	•	•
Executive Correspondence	•	•	•	
Routine Correspondence	•	•	•	•
Hard-to-Image Originals*				
Example: Engineering Drawings	•			•
OCR	•		•	
Manifolding	•		•	•
Speech Writing†	•		•	•
Negotiable Instruments – (checks, stocks, etc.)				
Erasable Bond*	•		•	
Reproduction Applications				
Heat Transfer	•	•	•	•
Transfer Electrostatic	•	•	•	•
Direct Electrostatic	•	•	•	•
Offset Masters, Direct to Plate	•		•	•
Offset Masters, Copier Process	•	•	•	•
Offset Masters, Photo Process	•		•	•
Diazo Process, Ozalid ¹ or Bruning ²	•	•	•	•

When typing Direct Image Offset Masters, the IBM Film Ribbon Cartridge or the IBM Tech III Ribbon should be used. When typing negotiable instruments, the IBM Tech III Ribbon should be used.

*The receptivity of the surface of these materials varies widely and care must be used in the selection of a specific material to be typed on, type style, impression control and ribbon to produce the best result. When in doubt, prepare samples first.

†Best results with Orator and other large type style elements are obtained by using the IBM Tech III Ribbon.

¹ Trademark of the GAF Corporation.

² Trademark of the Charles Bruning Co., Inc.

Optional Features

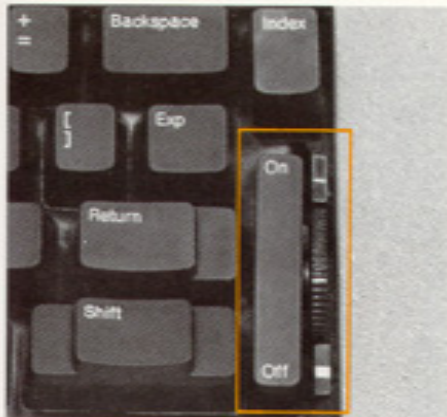

Velocity Control Dial

This dial is used when typing with foreign language and technical typing elements.

Hold the dial at the thin mark to type small characters such as accent marks.

Move the dial toward the thick line when typing in upper case with elements containing a ten-key numerical cluster, or some foreign language elements with large characters in the keyboard positions normally reserved for punctuation.

For a standard element, keep the dial at the center position.

Dead Key

If you regularly use a library, language, or trilingual typing element, your typewriter should be equipped with the dead key feature. With dead key, you can type accent marks without the carrier advancing to the next space.

To use the feature, first type the accent mark; then, type the alphabetic character. The carrier will move after the alphabetic character is typed.

You must space forward before pressing the correcting key when correcting a character on a dead key.

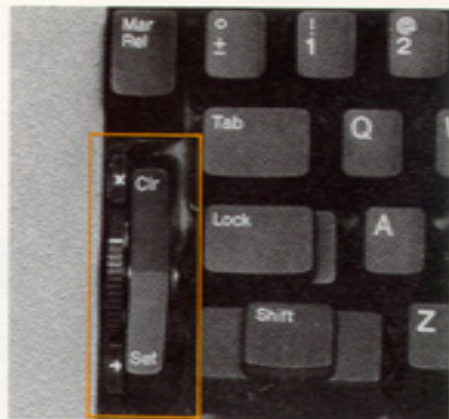

Dead Key Disconnect

Standard correspondence elements can also be used on typewriters equipped with dead keys through the use of the dead key disconnect feature.

To allow normal use of a dead key, set the dial at the X position when using a library, language, or trilingual typing element.

Set the dead key disconnect dial at the → position for a correspondence element. When the dial is set here, the carrier will space to the next typing position for all characters as they print.



Acoustical Hood

You can insert paper in the typewriter without lifting the acoustical hood.

- The visor is adjustable to deflect light.

When lifting the cover, pull the acoustical hood toward you, then lift the cover.

Use a damp cloth and mild soap to clean the hood. Do not use liquid type cleaner.



Pull the hood toward you when you need access to the paper in the typewriter (example, erasing errors, correcting carbons, etc.).

- Lift the hood up and back to change the element or impression control.



Legal Size End-of-Page Indicator

Raise the legal size extension.

Use the legal size extension to print legal size documents.

Use the legal size extension to print legal size documents.

Use the legal size extension to print legal size documents.

Use the legal size extension to print legal size documents.

Use the legal size extension to print legal size documents.

Use the legal size extension to print legal size documents.

Use the legal size extension to print legal size documents.

Use the legal size extension to print legal size documents.

Use the legal size extension to print legal size documents.

Use the legal size extension to print legal size documents.

Use the legal size extension to print legal size documents.

Use the legal size extension to print legal size documents.

Use the legal size extension to print legal size documents.

Use the legal size extension to print legal size documents.

Use the legal size extension to print legal size documents.

Use the legal size extension to print legal size documents.

Use the legal size extension to print legal size documents.

Use the legal size extension to print legal size documents.

Use the legal size extension to print legal size documents.

Use the legal size extension to print legal size documents.

Your IBM Sales Representative

Name _____

Telephone _____ Ext. _____

Address _____

Your IBM Customer Engineer

Name _____

Telephone _____ Ext. _____

Address _____

Your IBM Supplies Representative

Name _____

Telephone _____ Ext. _____

Address _____



International Business Machines Corporation
Office Products Division
For additional information, consult the nearest IBM Branch Office.
OPD Form No. G544-0613-1 Printed in USA 1279/880

PN 1304900